

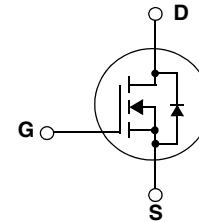
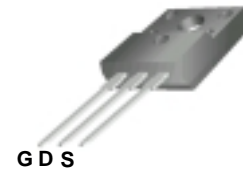


## WFF4N60

### 600V N-Channel MOSFET

#### Features

- Low Intrinsic Capacitances
- Excellent Switching Characteristics
- Extended Safe Operating Area
- Unrivalled Gate Charge :Qg= 15nC (Typ.)
- BVDSS=600V, ID=4A
- R<sub>DS(on)</sub> :2.3 Ω (Max) @VG=10V
- 100% Avalanche Tested



TO-220F

G-Gate,D-Drain,S-Source

### Absolute Maximum Ratings *T<sub>c</sub>=25°C unless other wise noted*

Symbol	Parameter	WFF4N60	Units
V <sub>DSS</sub>	Drain-Source Voltage	600	V
I <sub>D</sub>	Drain Current -continuous (T <sub>c</sub> =25°C)	4*	A
	-continuous (T <sub>c</sub> =100°C)	2.8*	A
V <sub>GS</sub>	Gate-Source Voltage	±30	V
E <sub>AS</sub>	Single Plused Avanche Energy (Note1)	240	mJ
I <sub>AR</sub>	Avalanche Current (Note2)	4	A
P <sub>D</sub>	Power Dissipation (T <sub>c</sub> =25°C)	33	W
T <sub>J</sub> ,T <sub>STG</sub>	Operating and Storage Temperature Range	-55 ~ +150	°C
TL	Maximum lead temperature for soldering purpose, 1/8" from case for 5 seconds	300	°C

### Thermal Characteristics

Symbol	Parameter	Typ.	Max	Units
R <sub>θJC</sub>	Thermal Resistance,Junction to Case	--	3.47	°C/W
R <sub>θJA</sub>	Thermal Resistance,Junction to Ambient	--	62.5	°C/W

\* Drain current limited by maximum junction temperature.

<b>Electrical Characteristics</b> Tc=25°C unless other wise noted						
Symbol	Parameter	Test Condition	Min.	Typ.	Max	Units
<b>Off Characteristics</b>						
BV <sub>DSS</sub>	Drain-Source Breakdown Voltage	ID=250 μ A, VGS=0	600	--	--	V
ΔBV <sub>DSS</sub> / ΔT <sub>J</sub>	Breakdown Voltage Temperature Coefficient	ID=250 μ A, Reference to 25°C	--	0.6	--	V/°C
IDSS	Zero Gate Voltage Drain Current	Vds=600V, Vgs=0V	--	--	10	μ A
		Vds=480V, Tc=125°C			100	μ A
IGSSF	Gate-body leakage Current, Forward	Vgs=+30V, Vds=0V	--	--	100	nA
IGSSR	Gate-body leakage Current, Reverse	Vgs=-30V, Vds=0V	--	--	-100	nA
<b>On Characteristics</b>						
V <sub>GS(th)</sub>	Gate Threshold Voltage	Id=250uA, Vds=Vgs	2	--	4	V
R <sub>DS(on)</sub>	Static Drain-Source On-Resistance	Id=2A, Vgs=10V	--	--	2.3	Ω
<b>Dynamic Characteristics</b>						
Ciss	Input Capacitance	VDS=25V, VGS=0, f=1.0MHz	--	520	670	pF
Coss	Output Capacitance		--	70	90	pF
Crss	Reverse Transfer Capacitance		--	8	11	pF
<b>Switching Characteristics</b>						
Td(on)	Turn-On Delay Time	VDD=300V, ID=4A RG=25 Ω (Note 3,4)	--	13	35	nS
Tr	Turn-On Rise Time		--	45	100	nS
Td(off)	Turn-Off Delay Time		--	25	60	nS
Tf	Turn-Off Fall Time		--	35	80	nS
Qg	Total Gate Charge	VDS=480, VGS=10V, ID=4A (Note 3,4)	--	15	20	nC
Qgs	Gate-Source Charge		--	3.4	--	nC
Qgd	Gate-Drain Charge		--	7.1	--	nC
<b>Drain-Source Diode Characteristics and Maximum Ratings</b>						
IS	Maximum Continuous Drain-Source Diode Forward Current		--	--	4	A
ISM	Maximum Pulsed Drain-Source Diode Forward Current		--	--	16	A
VSD	Drain-Source Diode Forward Voltage	Id=4A	--	--	1.25	V
trr	Reverse Recovery Time	IS=4A, VGS =0V	--	250	--	nS
Qrr	Reverse Recovery Charge	diF/dt=100A/ μ s (Note3)	--	1.25	--	μ C
*Notes	1, L=27.5mH, IAS=4A, VDD=50V, RG=25Ω, Starting TJ =25°C 2, Repetitive Rating : Pulse width limited by maximum junction temperature 3, Pulse Test : Pulse Width ≤ 300μs, Duty Cycle ≤ 2% 4, Essentially Independent of Operating Temperature					

# Typical Characteristics

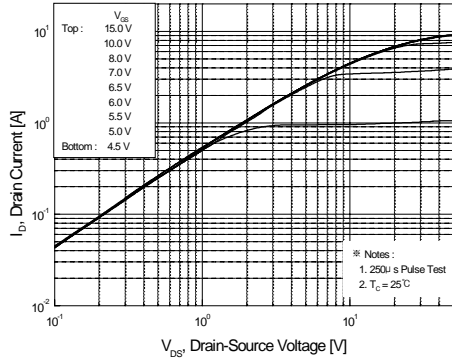


Figure 1. On-Region Characteristics

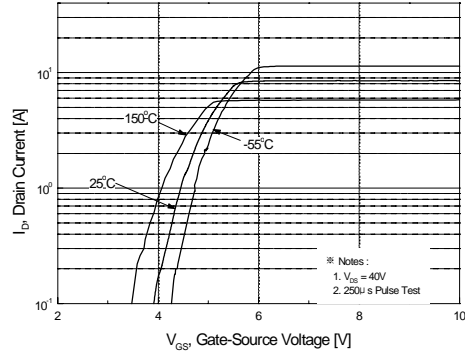


Figure 2. Transfer Characteristics

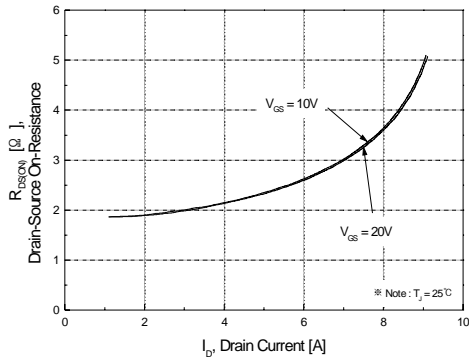


Figure 3. On-Resistance Variation vs Drain Current and Gate Voltage

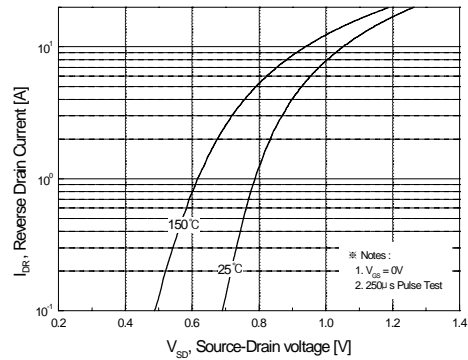


Figure 4. Body Diode Forward Voltage Variation with Source Current and Temperature

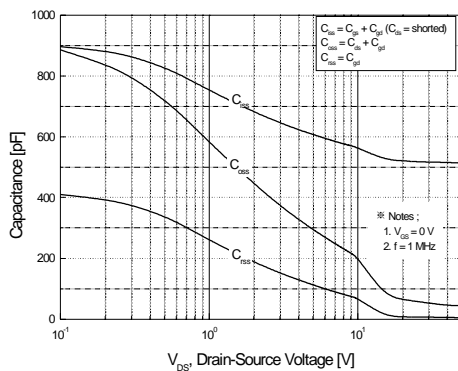


Figure 5. Capacitance Characteristics

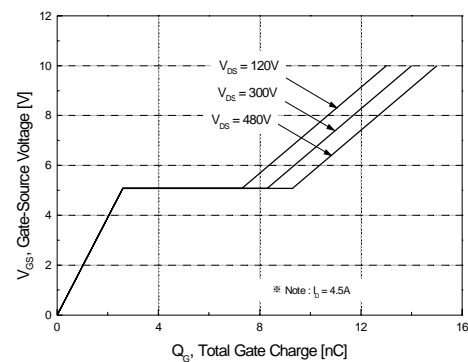
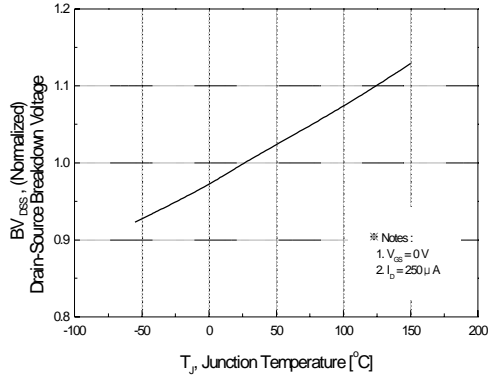
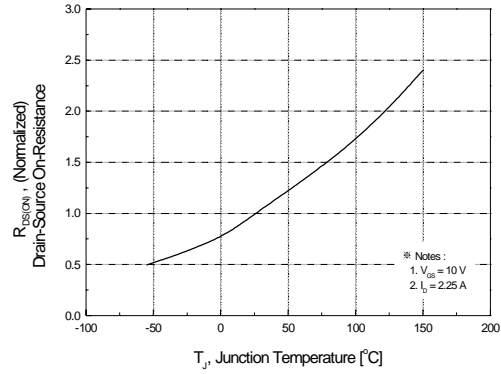


Figure 6. Gate Charge Characteristics

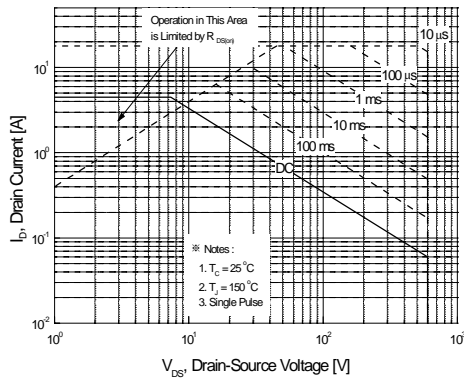
**Typical Characteristics (Continued)**



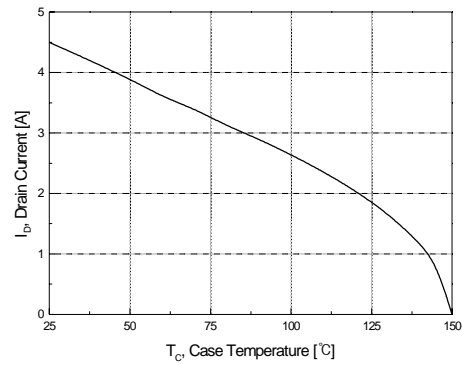
**Figure 7. Breakdown Voltage Variation vs Temperature**



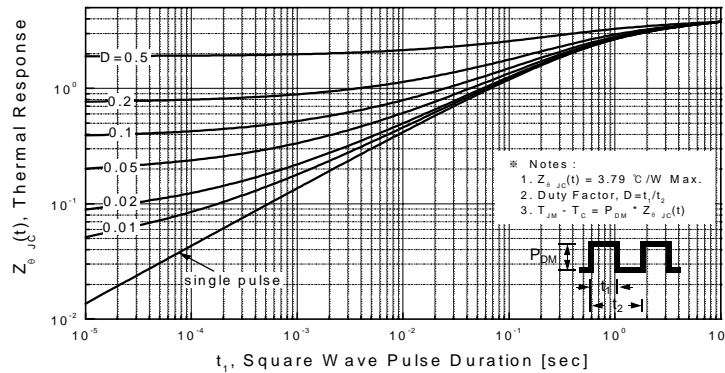
**Figure 8. On-Resistance Variation vs Temperature**



**Figure 9-2. Maximum Safe Operating Area for WFF4N60**

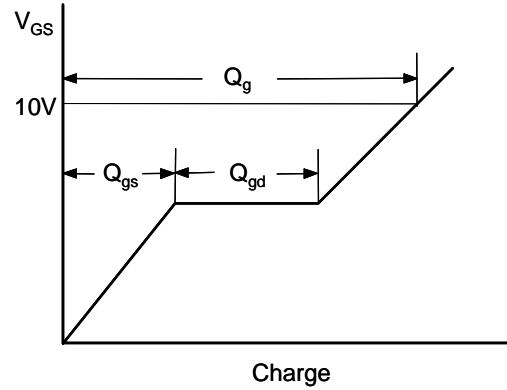
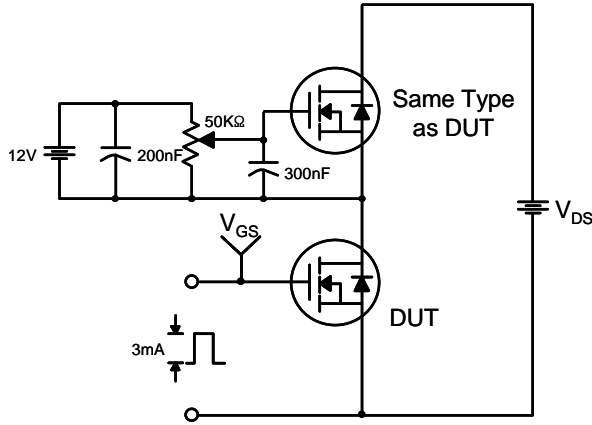


**Figure 10. Maximum Drain Current vs Case Temperature**

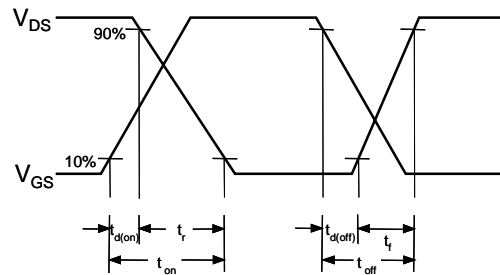
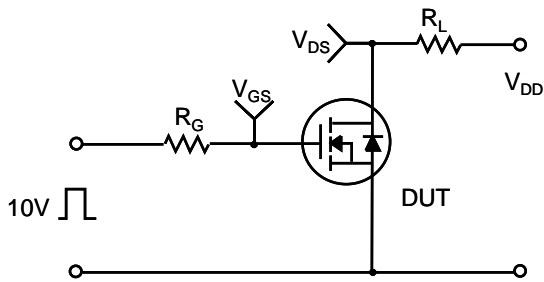


**Figure 11-2. Transient Thermal Response Curve for WFF4N60**

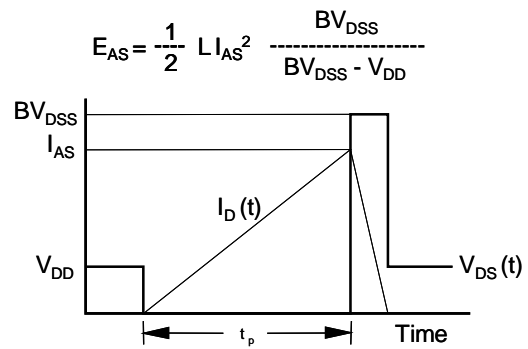
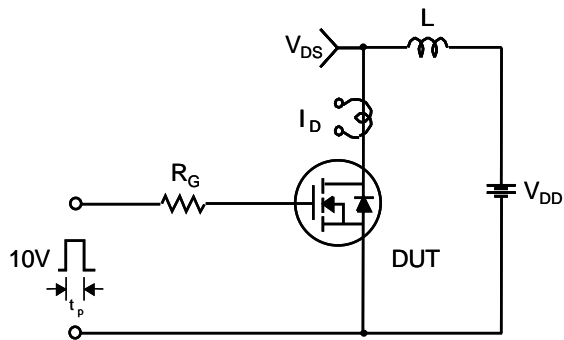
**Gate Charge Test Circuit & Waveform**



**Resistive Switching Test Circuit & Waveforms**



**Unclamped Inductive Switching Test Circuit & Waveforms**



Peak Diode Recovery dv/dt Test Circuit & Waveforms

