

XC62RP

Series



Positive Voltage Regulators for Voltage Reference Source

- ◆ CMOS Low Power Consumption
- ◆ Input-Output Voltage Differential : 140mV @ 300μA
- ◆ Maximum Output Current : 6.0mA (2.0V)
- ◆ Highly Accurate : ±2% (±1%)
- ◆ Output Voltage Range: 1.5V~3.5V
- ◆ No Load Power Consumption : 3.2μA (2.0V)
- ◆ SOT-23/SOT-89/TO-92 Package

Applications

- Battery Powered Equipment
- Reference Voltage Sources
- Cameras and Video Recorders
- Palmtops

3

General Description

The XC62RP series are highly precise, low power consumption, positive voltage regulators, for voltage reference source, manufactured using CMOS and laser trimming technologies.

SOT-23 (150mW), SOT-89 (500mW) and TO-92 (300mW) packages are available.

Features

- Maximum Output Current** : 6.0mA (within max. power dissipation, $V_{OUT}=2.0V$)
- Output Voltage Range** : 1.5V ~ 3.5V in 0.1V increments
- Highly Accurate** : Set-up Voltage ±2% (±1% for semi-custom products)
- Low Power Consumption** : TYP 3.2μA ($V_{OUT}=2.0$)
- Output Voltage Temperature Characteristics** : TYP ±100ppm/°C
- Input Stability** : TYP 0.2%/V
- Ultra Small Packages** : SOT-23 (150mW) mini-mold
SOT-89 (500mW) mini-power mold
TO-92 (300mW)

Typical Application Circuit

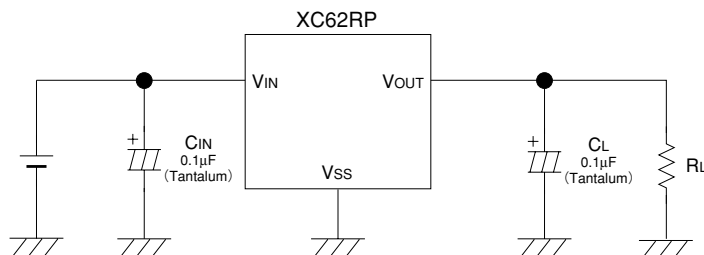

Please use with a load capacitance (C_L) of less than 0.1μF.

Typical Performance Characteristic

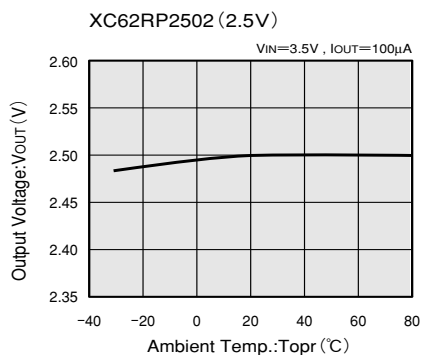

Pin Configuration

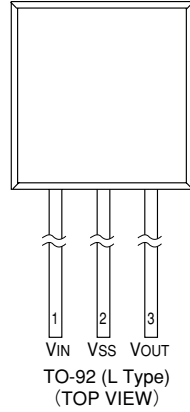
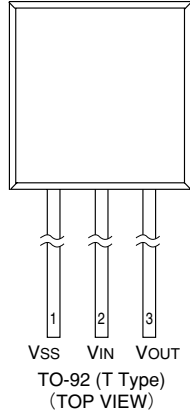
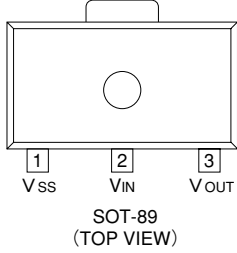
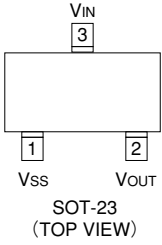

3

Pin Assignment

PIN NUMBER				PIN NAME	FUNCTION
SOT-23	SOT-89	TO-92 (T)	TO-92 (L)		
1	1	1	2	Vss	Ground
3	2	2	1	Vin	Supply Voltage Input
2	3	3	3	Vout	Output

Product Classification

Ordering Information

X C 6 2 R X X X X X X X
 ↑ ↑ ↑ ↑ ↑ ↑
 a b c d e f

DESIGNATOR	DESCRIPTION	DESIGNATOR	DESCRIPTION
a	Polarity of Output Voltage: P: + (Positive)	e	Package Type M=SOT-23 P=SOT-89 T=TO-92 (Standard) L=TO-92 (Custom pin configuration)
b	Output Voltage 15=1.5V 30=3.0V		
c	Temperature Coefficients: 0=±100ppm (Typical)	f	Device Orientation R=Embossed Tape (Standard Feed) L=Embossed Tape (Reverse Feed) H=Paper Tape (TO-92) B=Bag (TO-92)
d	Output Voltage Accuracy: 1=±1.0% (Semi-custom) 2=±2.0%		

■ Packaging Information

● SOT-23

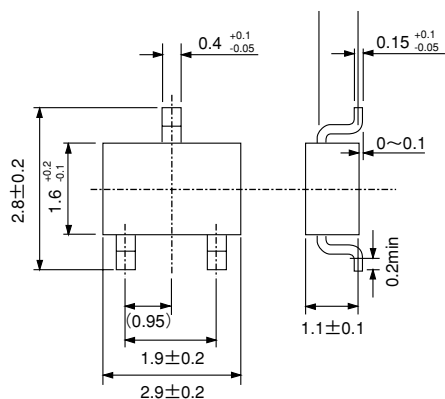

● SOT-89

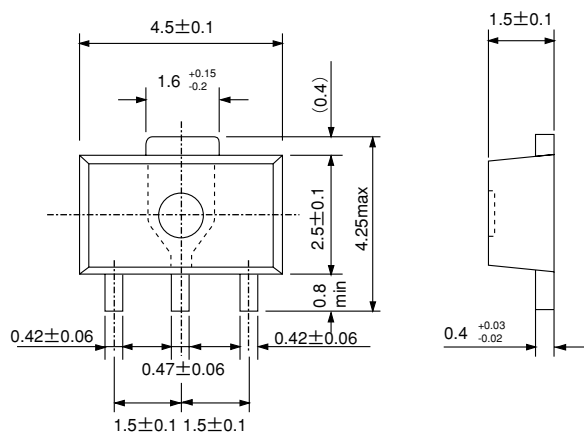

●TO-92

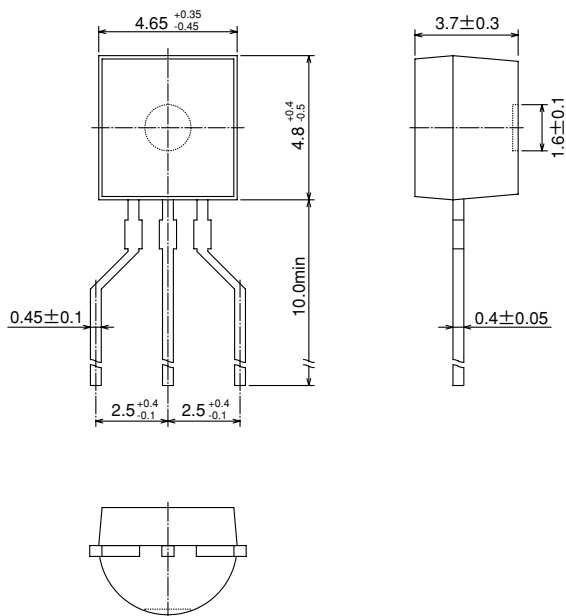

3

■Marking

●SOT-23, SOT-89

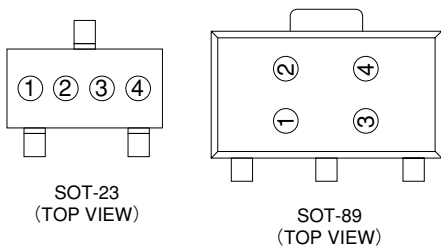

③ Represents the decimal number of the Output Voltage

SYMBOL	VOLTAGE(V)	SYMBOL	VOLTAGE(V)
A	②.0	F	②.5
B	②.1	H	②.6
C	②.2	K	②.7
D	②.3	L	②.8
E	②.4	M	②.9

① Not Used.

② Represents the integer of the Output Voltage

SYMBOL	VOLTAGE(V)
A	0.③
B	1.③
C	2.③
D	3.③

④ Represents the assembly lot no.
Based on internal standards

●TO-92

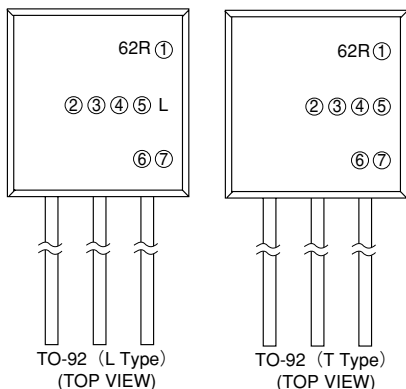

① Represents the polarity of Output Voltage

DESIGNATOR	CONFIGURATION
P	+

④ Represents the temperature characteristics

DESIGNATOR	TEMPERATURE CHARACTERISTICS
0	TPY±100ppm

⑤ Represents the Detect Voltage Accuracy

DESIGNATOR	DETECT VOLTAGE ACCURACY
1	within ±1% (semi-custom)
2	within ±2%

⑥ Represents a least significant digit of the produced year

DESIGNATOR	PRODUCED YEAR
0	2000
1	2001

⑦ Denotes the production lot number
0 to 9, A to Z repeated(G.I.J.O.Q.W excepted)

②③ Represents the Detect Voltage

DESIGNATOR		VOLTAGE (V)
②	③	
3	3	3.3
5	0	5.0

■Block Diagram

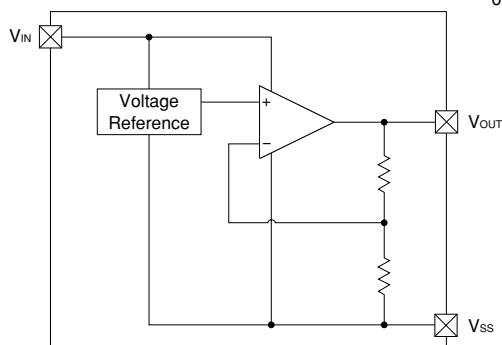

■Absolute Maximum Ratings

Ta=25°C

PARAMETER	SYMBOL	RATINGS	UNITS
Input Voltage	V _{IN}	12	V
Output Current	I _{OUT}	50	mA
Output Voltage	V _{OUT}	V _{SS} -0.3 ~ V _{IN} +0.3	V
Continuous Total Power Dissipation	SOT-23	Pd	150
	SOT-89		500
	TO-92		300
Operating Ambient Temperature	T _{opr}	-30 ~ +80	°C
Storage Temperature	T _{stg}	-40 ~ +125	°C

Note: I_{OUT} must be less than Pd / (V_{IN}-V_{OUT}).

Electrical Characteristics

XC62RP1602 $V_{OUT}(T)=1.6V$ (Note1)

$T_a=25^{\circ}C$

PARAMETER	SYMBOL	CONDITIONS	MIN	TYP	MAX	UNITS	CIRCUIT
Output Voltage	$V_{OUT}(E)$ (Note2)	$I_{OUT}=100\mu A$ $V_{IN}=2.6V$	1.568	1.600	1.632	V	1
Maximum Output Current	$I_{OUT\ max}$	$V_{IN}=2.6V, V_{OUT}(E) \geq V_{OUT}(T) \times 0.95$	4.0			mA	1
Load Stability	ΔV_{OUT}	$V_{IN}=2.6V$ $100\mu A \leq I_{OUT} \leq 300\mu A$		20	40	mV	1
Input -Output Voltage Differential (Note3)	V_{dif1}	$I_{OUT}=100\mu A$		30	80	mV	1
	V_{dif2}	$I_{OUT}=300\mu A$		50	140	mV	1
Supply Current	I_{SS}	$V_{IN}=2.6V$		3.0	5.8	μA	2
Input Stability	$\frac{\Delta V_{OUT}}{\Delta V_{IN} \cdot V_{OUT}}$	$I_{OUT}=100\mu A$ $2.6V \leq V_{IN} \leq 6.0V$		0.2	0.3	%/V	1
Input Voltage	V_{IN}				6.0	V	—
Output Voltage Temperature Characteristics	$\frac{\Delta V_{OUT}}{\Delta T_{opr} \cdot V_{OUT}}$	$I_{OUT}=100mA$ $-30^{\circ}C \leq T_{opr} \leq 80^{\circ}C$		± 100		ppm/ $^{\circ}C$	1

XC62RP2002 $V_{OUT}(T)=2.0V$ (Note1)

$T_a=25^{\circ}C$

PARAMETER	SYMBOL	CONDITIONS	MIN	TYP	MAX	UNITS	CIRCUIT
Output Voltage	$V_{OUT}(E)$ (Note2)	$I_{OUT}=100\mu A$ $V_{IN}=3.0V$	1.960	2.000	2.040	V	1
Maximum Output Current	$I_{OUT\ max}$	$V_{IN}=3.0V, V_{OUT}(E) \geq V_{OUT}(T) \times 0.95$	6.0			mA	1
Load Stability	ΔV_{OUT}	$V_{IN}=3.0V$ $100\mu A \leq I_{OUT} \leq 300\mu A$		20	40	mV	1
Input -Output Voltage Differential (Note3)	V_{dif1}	$I_{OUT}=100\mu A$		30	80	mV	1
	V_{dif2}	$I_{OUT}=300\mu A$		50	140	mV	1
Supply Current	I_{SS}	$V_{IN}=3.0V$		3.2	6.2	μA	2
Input Stability	$\frac{\Delta V_{OUT}}{\Delta V_{IN} \cdot V_{OUT}}$	$I_{OUT}=100\mu A$ $3.0V \leq V_{IN} \leq 6.0V$		0.2	0.3	%/V	1
Input Voltage	V_{IN}				6.0	V	—
Output Voltage Temperature Characteristics	$\frac{\Delta V_{OUT}}{\Delta T_{opr} \cdot V_{OUT}}$	$I_{OUT}=100mA$ $-30^{\circ}C \leq T_{opr} \leq 80^{\circ}C$		± 100		ppm/ $^{\circ}C$	1

XC62RP2502 $V_{OUT}(T)=2.5V$ (Note1)

 $T_a=25^{\circ}C$

PARAMETER	SYMBOL	CONDITIONS	MIN	TYP	MAX	UNITS	CIRCUIT
Output Voltage	$V_{OUT}(E)$ (Note2)	$I_{OUT}=100\mu A$ $V_{IN}=3.5V$	2.450	2.500	2.550	V	1
Maximum Output Current	$I_{OUT\ max}$	$V_{IN}=3.5V, V_{OUT}(E)\geq V_{OUT}(T)\times 0.95$	8.0			mA	1
Load Stability	ΔV_{OUT}	$V_{IN}=3.5V$ $100\mu A\leq I_{OUT}\leq 300\mu A$		20	40	mV	1
Input -Output Voltage Differential (Note3)	V_{dif1}	$I_{OUT}=100\mu A$		30	80	mV	1
	V_{dif2}	$I_{OUT}=300\mu A$		50	140	mV	1
Supply Current	I_{SS}	$V_{IN}=3.5V$		3.5	6.8	μA	2
Input Stability	$\frac{\Delta V_{OUT}}{\Delta V_{IN} \cdot V_{OUT}}$	$I_{OUT}=100\mu A$ $3.5V\leq V_{IN}\leq 6.0V$		0.2	0.3	%/V	1
Input Voltage	V_{IN}				6.0	V	—
Output Voltage Temperature Characteristics	$\frac{\Delta V_{OUT}}{\Delta T_{opr} \cdot V_{OUT}}$	$I_{OUT}=100mA$ $-30^{\circ}C\leq T_{opr}\leq 80^{\circ}C$		± 100		ppm/ $^{\circ}C$	1

3
XC62RP3002 $V_{OUT}(T)=3.0V$ (Note1)

 $T_a=25^{\circ}C$

PARAMETER	SYMBOL	CONDITIONS	MIN	TYP	MAX	UNITS	CIRCUIT
Output Voltage	$V_{OUT}(E)$ (Note2)	$I_{OUT}=100\mu A$ $V_{IN}=4.0V$	2.940	3.000	3.060	V	1
Maximum Output Current	$I_{OUT\ max}$	$V_{IN}=4.0V, V_{OUT}(E)\geq V_{OUT}(T)\times 0.95$	10.0			mA	1
Load Stability	ΔV_{OUT}	$V_{IN}=4.0V$ $100\mu A\leq I_{OUT}\leq 300\mu A$		20	40	mV	1
Input -Output Voltage Differential (Note3)	V_{dif1}	$I_{OUT}=100\mu A$		30	80	mV	1
	V_{dif2}	$I_{OUT}=300\mu A$		50	140	mV	1
Supply Current	I_{SS}	$V_{IN}=4.0V$		3.8	7.3	μA	2
Input Stability	$\frac{\Delta V_{OUT}}{\Delta V_{IN} \cdot V_{OUT}}$	$I_{OUT}=100\mu A$ $4.0V\leq V_{IN}\leq 6.0V$		0.2	0.3	%/V	1
Input Voltage	V_{IN}				6.0	V	—
Output Voltage Temperature Characteristics	$\frac{\Delta V_{OUT}}{\Delta T_{opr} \cdot V_{OUT}}$	$I_{OUT}=100mA$ $-30^{\circ}C\leq T_{opr}\leq 80^{\circ}C$		± 100		ppm/ $^{\circ}C$	1

- Note:
- $V_{OUT}(T)$ =Specified Output Voltage .
 - $V_{OUT}(E)$ =Effective Output Voltage (i.e. the output voltage when " $V_{OUT}(T)+1.0V$ " is provided at the V_{IN} pin while maintaining a certain I_{OUT} value).
 - $V_{dif} = \{V_{IN1} \text{ (Note5)} - V_{OUT1} \text{ (Note4)}\}$
 - V_{OUT1} = A voltage equal to 98% of the Output Voltage whenever an amply stabilised I_{OUT} ($V_{OUT}(T)+1.0V$) is input.
 - V_{IN1} = The Input Voltage when V_{OUT1} appears as Input Voltage is gradually decreased.

Typical Application Circuit

Standard Circuit

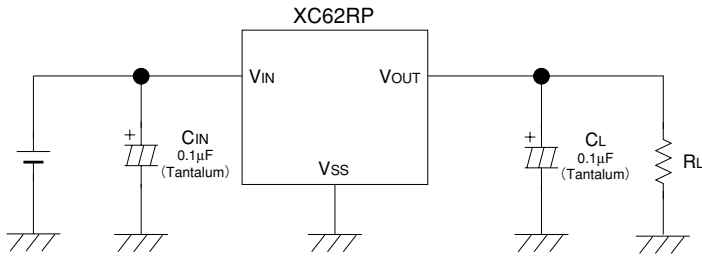

Please use with a load capacitance (C_L) of less than $0.1\mu\text{F}$.

3

Directions for use

Notes on Use

1. Please use with a load capacitance, C_L , of less than $0.1\mu\text{F}$ and in $0.01\mu\text{F}$ steps.
2. Since short-circuit protection is not built-in, the IC may be damaged by rush current should the output pin be connected to the Ground pin.
3. When the load capacitance, C_L , is small, overshoot will be produced when the power is switched on.
4. As the output pin's current is only a few μA , output voltage will increase should output be pulled-up by means of a resistor.

Test Circuits

Circuit 1

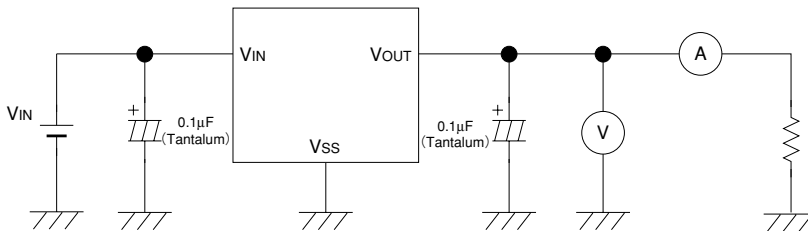

Circuit 2

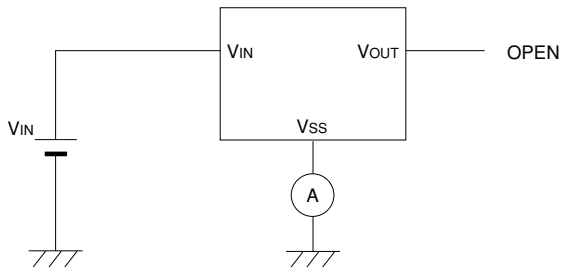

Typical Performance Characteristics

(1) OUTPUT VOLTAGE vs. OUTPUT CURRENT

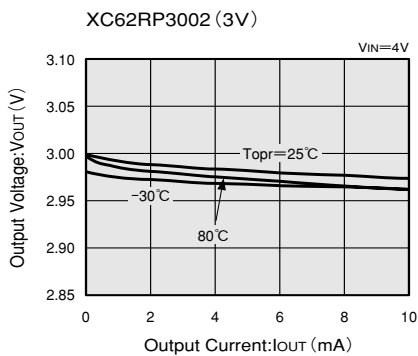
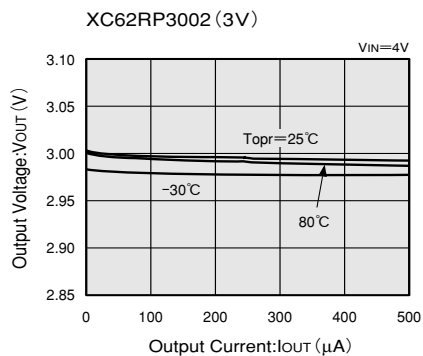
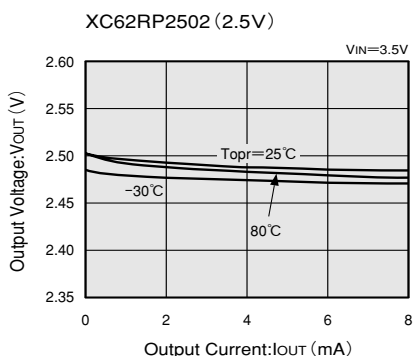
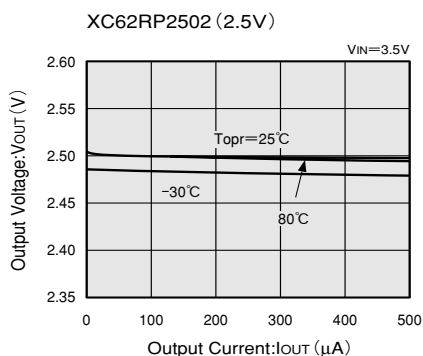
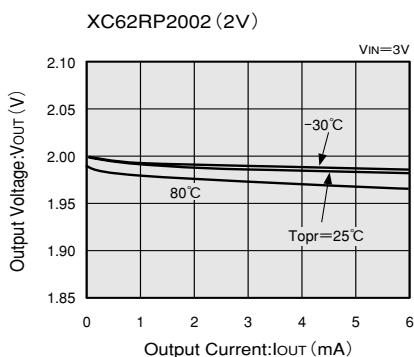
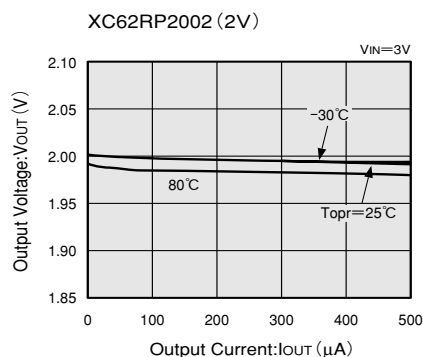
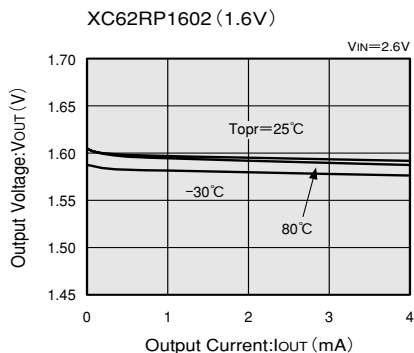
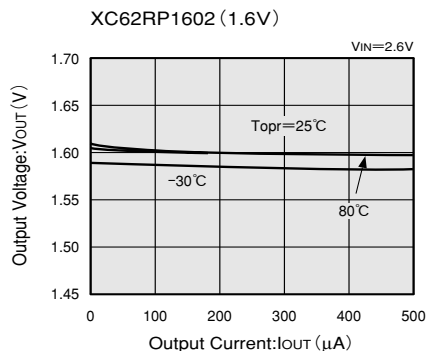

(2) OUTPUT VOLTAGE vs. INPUT VOLTAGE

3

XC62RP1602 (1.6V)

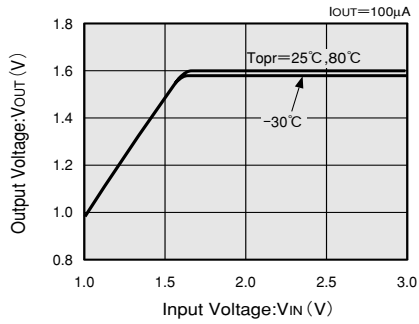

XC62RP1602 (1.6V)

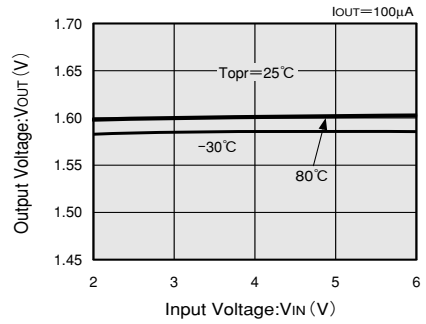

XC62RP2002 (2V)

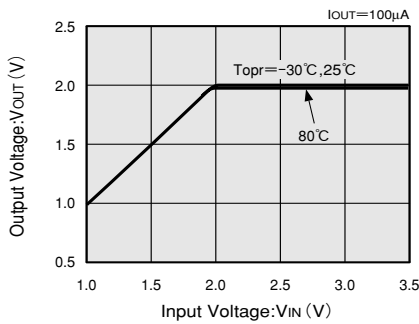

XC62RP2002 (2V)

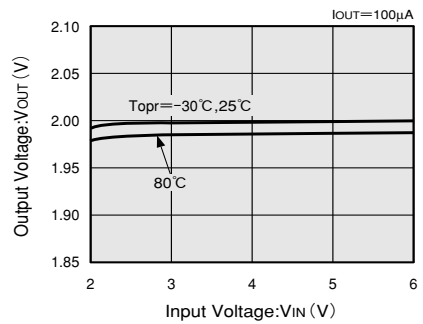

XC62RP2502 (2.5V)

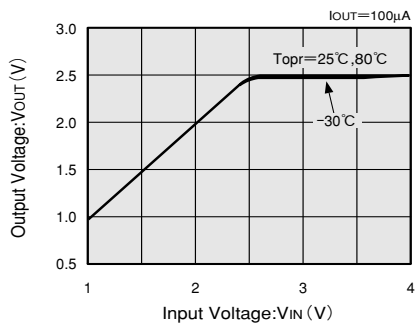

XC62RP2502 (2.5V)

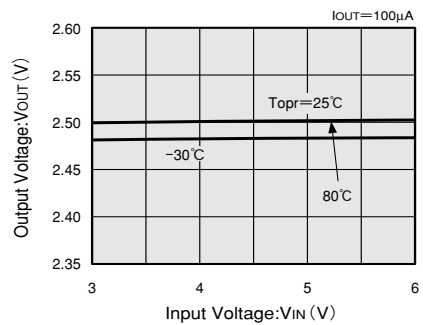

XC62RP3002 (3V)

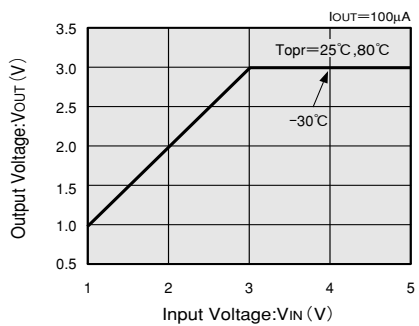

XC62RP3002 (3V)

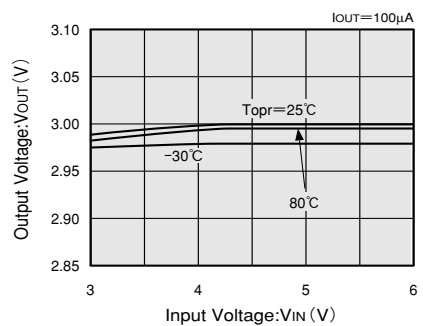

(3) INPUT/OUTPUT VOLTAGE DIFFERENTIAL vs. OUTPUT CURRENT

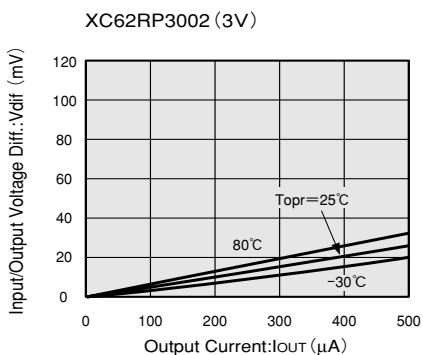
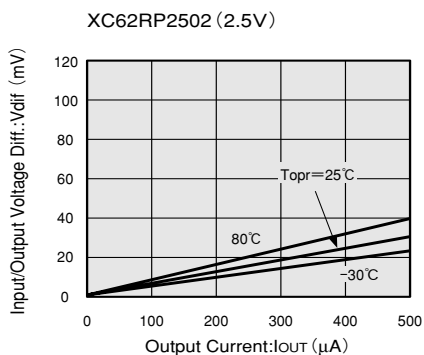
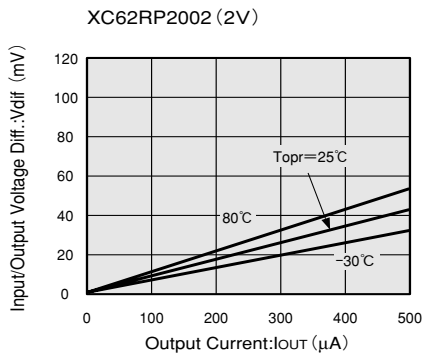
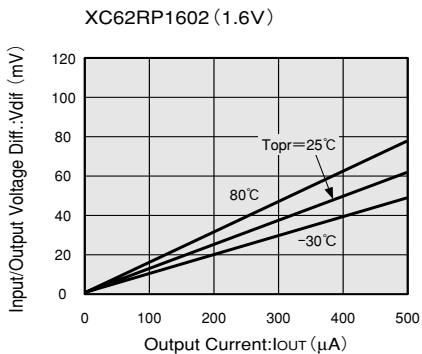

(4) SUPPLY CURRENT vs. INPUT VOLTAGE

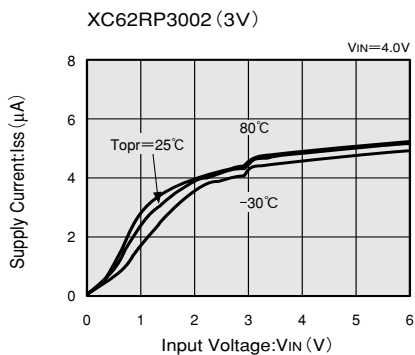
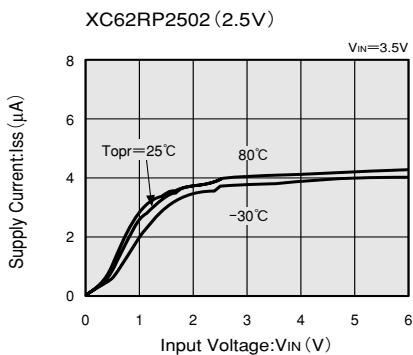
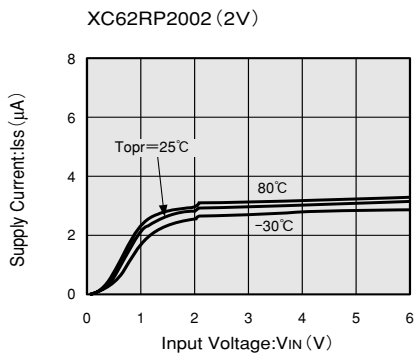
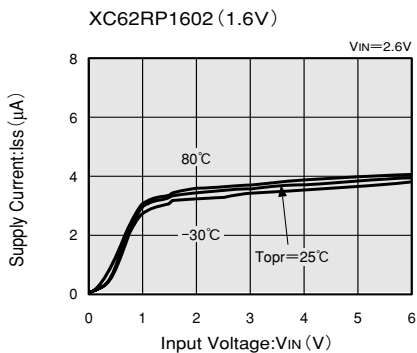

3

(5) OUTPUT VOLTAGE vs. AMBIENT TEMPERATURE

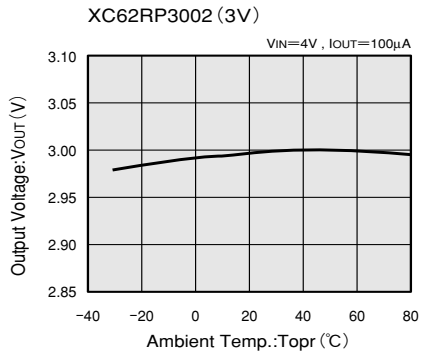
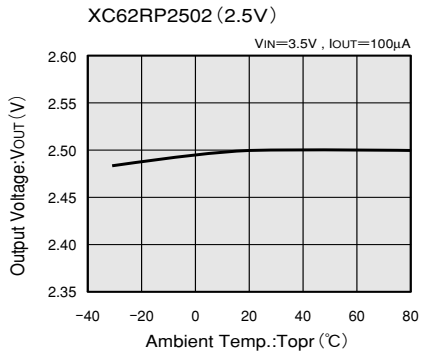
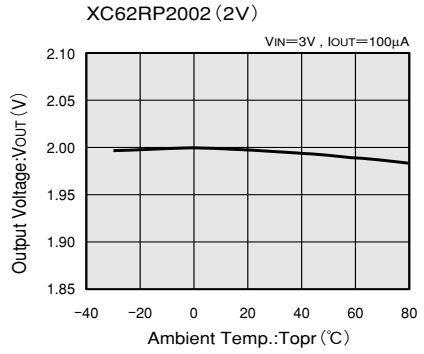
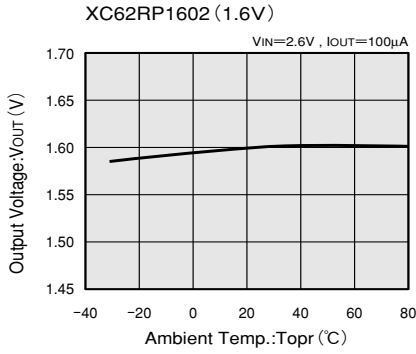

(6) SUPPLY CURRENT vs. AMBIENT TEMPERATURE

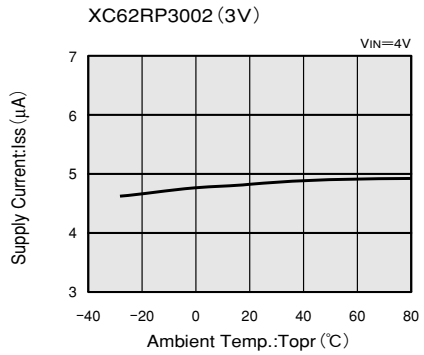
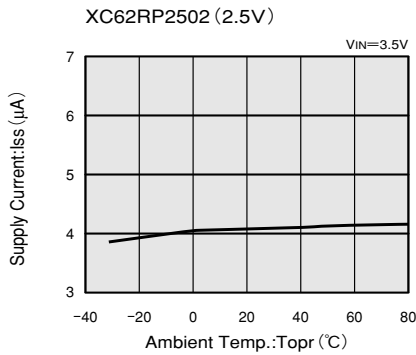
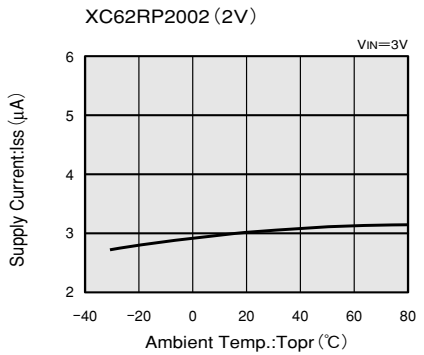
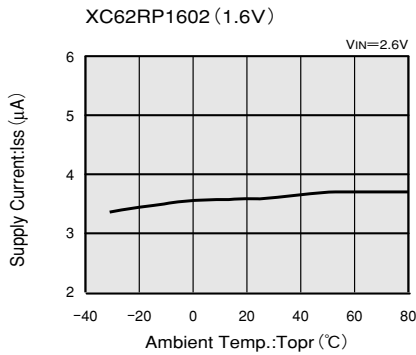

(7) INPUT TRANSIENT RESPONSE 1

XC62RP2002 (2V)

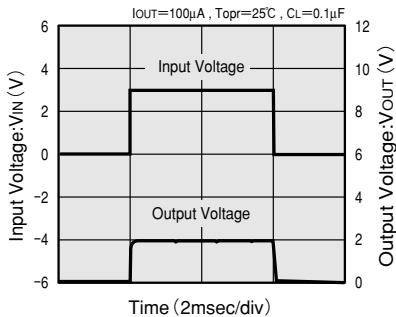

XC62RP2502 (2.5V)

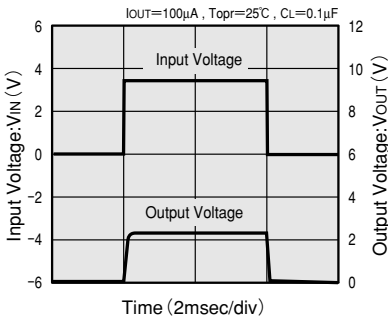

(8) INPUT TRANSIENT RESPONSE 2

XC62RP2002 (2V)

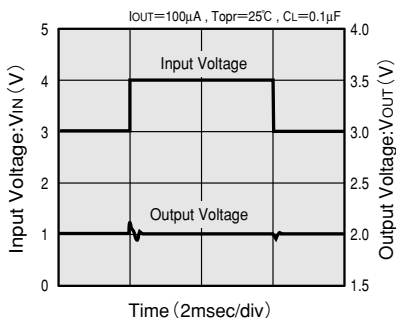

XC62RP2502 (2.5V)

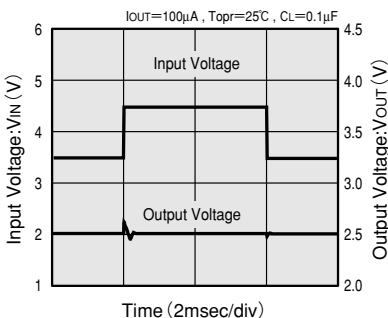

(9) LOAD TRANSIENT RESPONSE

XC62RP2002 (2V)

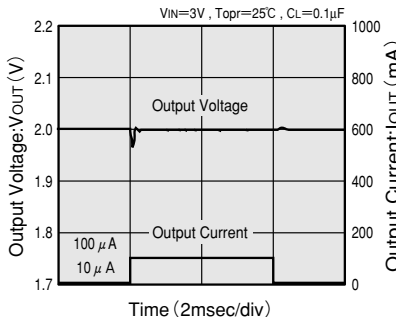

XC62RP2002 (2V)

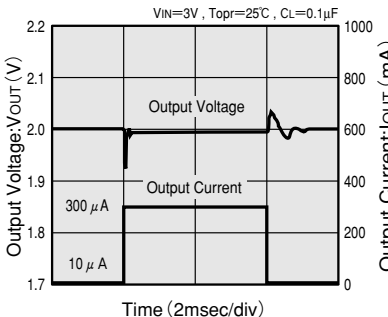

XC62RP2502 (2.5V)

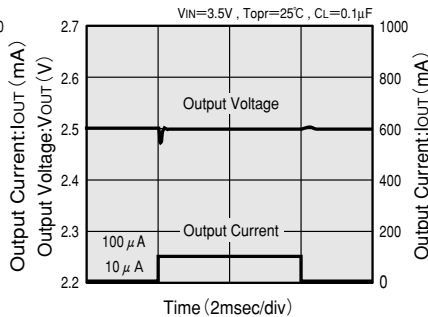

(10) RIPPLE REJECTION

XC62RP2502 (2.5V)

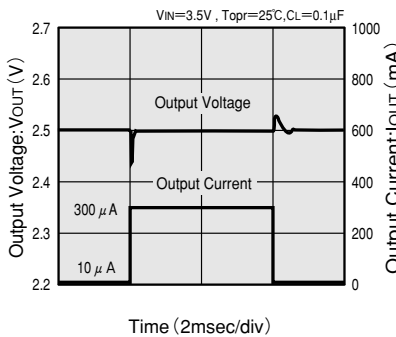

XC62RP2502 (2.5V)

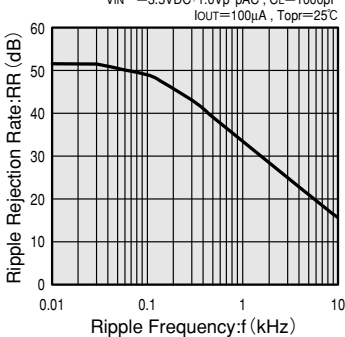

This datasheet has been downloaded from:

www.DatasheetCatalog.com

Datasheets for electronic components.